



# Cambridge IGCSE™

---

## COMBINED SCIENCE

0653/12

Paper 1 Multiple Choice (Core)

February/March 2021

45 minutes

You must answer on the multiple choice answer sheet.

You will need: Multiple choice answer sheet  
Soft clean eraser  
Soft pencil (type B or HB is recommended)

---

## INSTRUCTIONS

- There are **forty** questions on this paper. Answer **all** questions.
- For each question there are four possible answers **A, B, C** and **D**. Choose the **one** you consider correct and record your choice in soft pencil on the multiple choice answer sheet.
- Follow the instructions on the multiple choice answer sheet.
- Write in soft pencil.
- Write your name, centre number and candidate number on the multiple choice answer sheet in the spaces provided unless this has been done for you.
- Do **not** use correction fluid.
- Do **not** write on any bar codes.
- You may use a calculator.

## INFORMATION

- The total mark for this paper is 40.
- Each correct answer will score one mark.
- Any rough working should be done on this question paper.
- The Periodic Table is printed in the question paper.

---

This document has **16** pages.



1 What are the characteristics of living organisms?

	excretion	growth	movement	nutrition	reproduction	respiration	sensitivity / response
<b>A</b>	✓	✓	✓	✓	✓	✓	✓
<b>B</b>	✓	✓	x	✓	✓	✓	✓
<b>C</b>	✓	x	x	✓	x	✓	✓
<b>D</b>	x	✓	✓	✓	✓	✓	x

2 The diagram shows a plant cell.

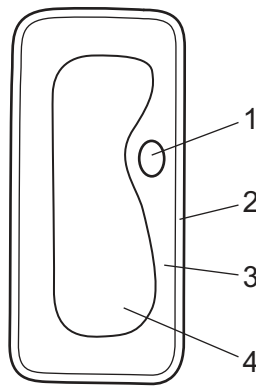

Which structures are also found in an animal cell?

- A** 1 and 3      **B** 1 and 4      **C** 2 and 3      **D** 2 and 4

3 What are the smaller molecules that make up fats, protein and starch?

	fats	protein	starch
<b>A</b>	glucose	glycogen	fatty acids and glycerol
<b>B</b>	glucose	amino acids	glycogen
<b>C</b>	fatty acids and glycerol	amino acids	glucose
<b>D</b>	fatty acids and glycerol	glycogen	amino acids

4 What are enzymes made from?

- A** carbohydrates  
**B** fats  
**C** proteins  
**D** sugars

5 The diagram shows a section of a leaf.

Which letter is the epidermis?

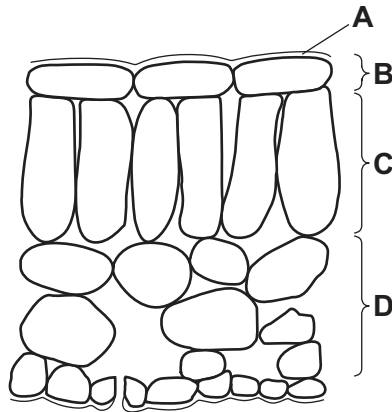

6 Which diagram represents the digestion of food molecules in the alimentary canal?

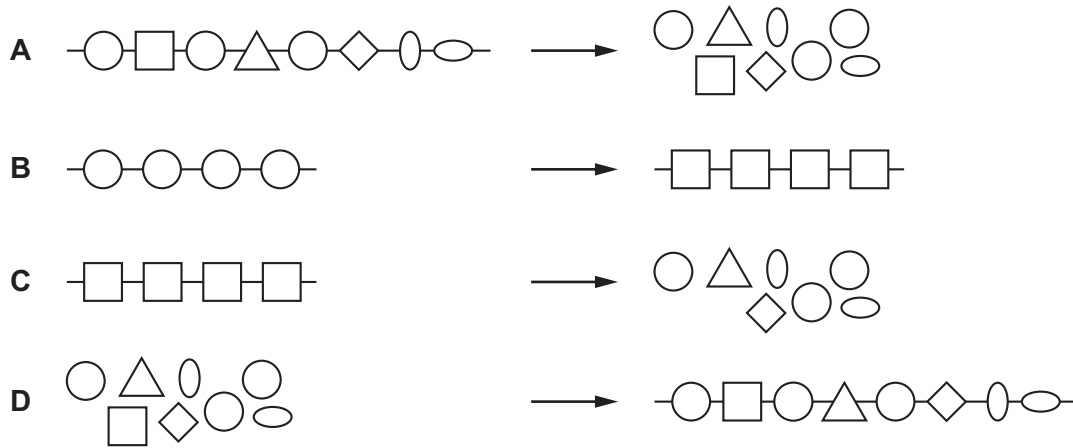

7 What is the function of valves in the circulatory system?

- A to act as a pump
- B to ensure blood only flows one way
- C to provide a large surface area
- D to stop blood vessels bursting

8 The graphs show the effects of different levels of activity on the rate and depth of breathing.

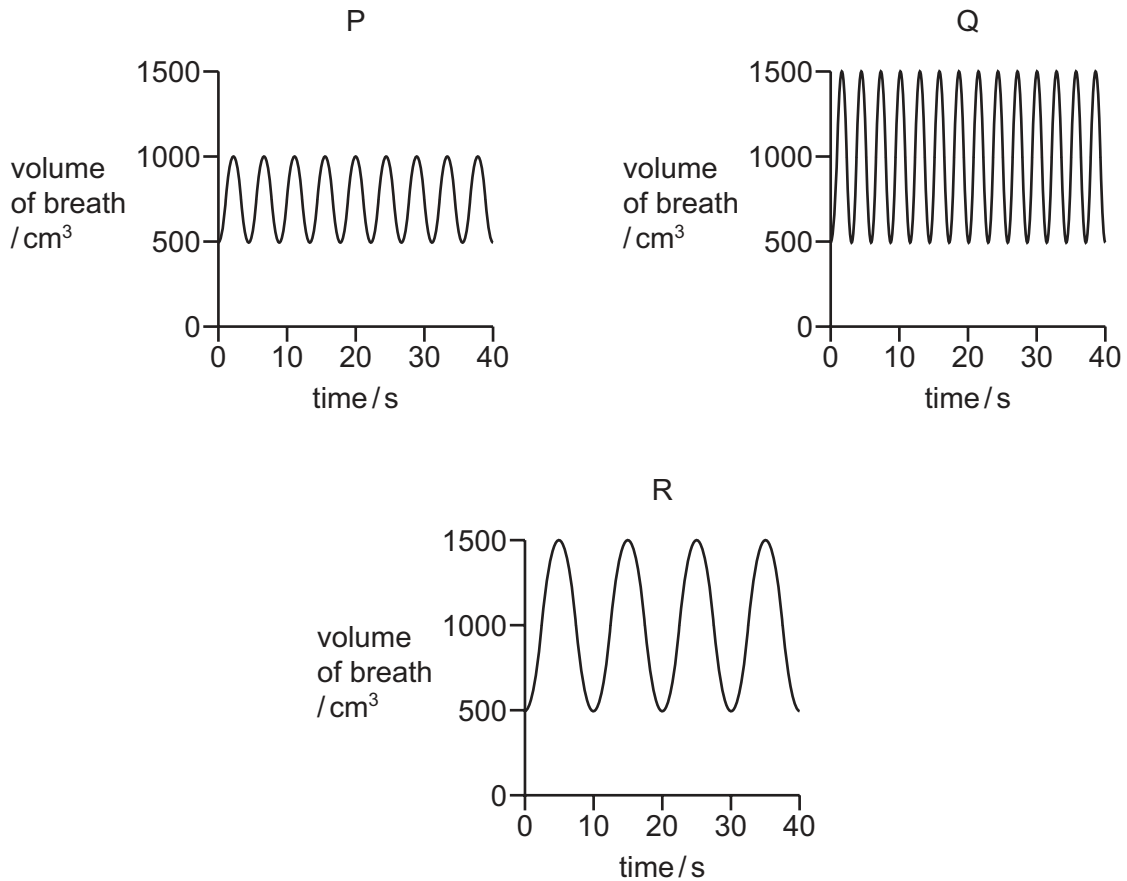

Which graphs show the rate and depth of breathing during exercise and during rest?

	exercise	rest
<b>A</b>	P	Q
<b>B</b>	P	R
<b>C</b>	Q	P
<b>D</b>	Q	R

9 If the aerobic respiration equation was  $1 + 2 \rightarrow 3 + 4$ , which row would show the correct equation?





	1	2	3	4
<b>A</b>	carbon dioxide	glucose	oxygen	water
<b>B</b>	glucose	oxygen	water	carbon dioxide
<b>C</b>	oxygen	water	carbon dioxide	glucose
<b>D</b>	water	carbon dioxide	glucose	oxygen

10 The table shows some data recorded by a scientist about a student.

pupil size in eye	pulse rate /beats per minute
	68

The scientist then frightens the student with a sudden loud noise.

Which row shows the results immediately after the loud noise?

	pupil size in eye	pulse rate /beats per minute
<b>A</b>		60
<b>B</b>		80
<b>C</b>		60
<b>D</b>		80

11 Which row is correct for asexual reproduction?

	offspring are genetically identical	number of parents
<b>A</b>	yes	one
<b>B</b>	yes	two
<b>C</b>	no	one
<b>D</b>	no	two

12 The diagram shows a food web.

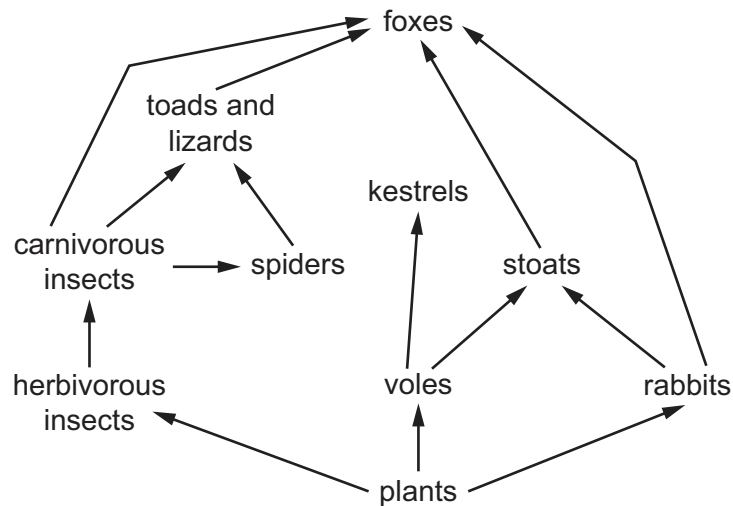

Which organisms in this food web are secondary consumers?

- A carnivorous insects and voles
  - B foxes and lizards
  - C kestrels and stoats
  - D spiders and stoats
- 13 Which process in the carbon cycle releases carbon back into the atmosphere?
- A feeding
  - B fossilisation
  - C photosynthesis
  - D respiration
- 14 Which methods of separation depend on the substances in a mixture having different boiling points?
- A crystallisation and distillation
  - B evaporation and filtration
  - C fractional distillation and chromatography
  - D fractional distillation and distillation

15 Which row describes an element and a compound?

	element	compound
<b>A</b>	contains more than one type of atom	contains elements chemically combined
<b>B</b>	contains more than one type of atom	contains elements mixed together
<b>C</b>	contains only one type of atom	contains elements chemically combined
<b>D</b>	contains only one type of atom	contains elements mixed together

16 The apparatus shown is set up.

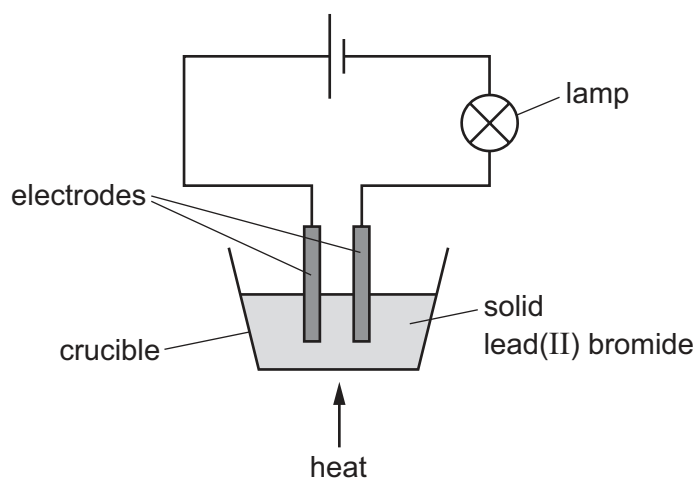

The crucible needs to be heated for the lamp to give out light.

Why is heat needed?

- A** An exothermic reaction takes place in the crucible.
- B** Electrodes only conduct electricity when hot.
- C** Heat causes the lead(II) bromide to react with air.
- D** The lead(II) bromide must be molten.

17 Which word is used to describe a reaction that takes in heat energy from the surroundings?

- A** endothermic
- B** exothermic
- C** oxidation
- D** reduction

- 18 Four separate samples of magnesium are reacted with dilute hydrochloric acid. In each reaction the concentration of the hydrochloric acid is the same.

Which experiment gives the highest rate of reaction?

- A 2 g of magnesium powder in 25 cm<sup>3</sup> of dilute hydrochloric acid at 50 °C
  - B 2 g of magnesium powder in 50 cm<sup>3</sup> of dilute hydrochloric acid at 25 °C
  - C 2 g of magnesium ribbon in 25 cm<sup>3</sup> of dilute hydrochloric acid at 25 °C
  - D 2 g of magnesium ribbon in 50 cm<sup>3</sup> of dilute hydrochloric acid at 50 °C
- 19 Which equation represents a reaction in which oxidation and reduction occur?
- A  $\text{CaCO}_3 \rightarrow \text{CaO} + \text{CO}_2$
  - B  $2\text{H}_2 + \text{O}_2 \rightarrow 2\text{H}_2\text{O}$
  - C  $\text{Na}_2\text{CO}_3 + \text{ZnSO}_4 \rightarrow \text{Na}_2\text{SO}_4 + \text{ZnCO}_3$
  - D  $\text{NaOH} + \text{HCl} \rightarrow \text{NaCl} + \text{H}_2\text{O}$
- 20 A mixture of ammonium carbonate and ammonium chloride is heated with aqueous sodium hydroxide.

Which gas is produced?

- A ammonia
- B carbon dioxide
- C chlorine
- D hydrogen chloride



- 21 The diagram shows what happens when damp red litmus paper is placed into two different gases, X and Y.

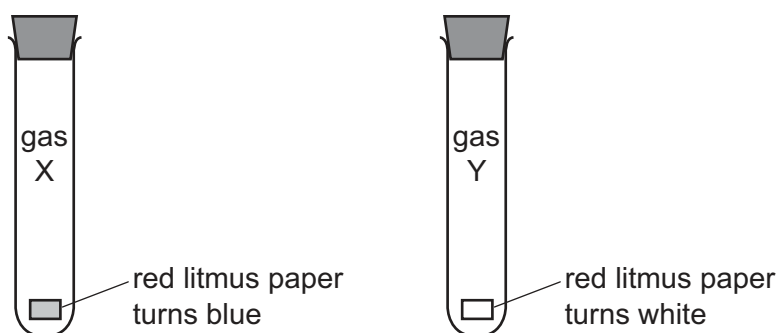

What are gases X and Y?

	X	Y
<b>A</b>	ammonia	carbon dioxide
<b>B</b>	ammonia	chlorine
<b>C</b>	chlorine	ammonia
<b>D</b>	chlorine	carbon dioxide

- 22 Which statement about the elements in Group I of the Periodic Table is correct?

- A** They are hard solids.
- B** They change from metallic to non-metallic down the group.
- C** They react with water to form oxygen.
- D** They become more reactive down the group.

- 23 Some information about four metals P, Q, R and S is listed.

P does not react with dilute hydrochloric acid.

Q reacts violently with water.

R reacts slowly with dilute hydrochloric acid.

The oxide of S does not react with carbon.

Which row identifies P, Q, R and S?

	P	Q	R	S
<b>A</b>	aluminium	potassium	iron	zinc
<b>B</b>	aluminium	calcium	zinc	potassium
<b>C</b>	copper	potassium	iron	aluminium
<b>D</b>	copper	calcium	zinc	magnesium

24 Which change shows the presence of water?

- A Anhydrous copper(II) sulfate turns white.
- B Anhydrous copper(II) sulfate turns pink.
- C Cobalt(II) chloride paper turns pink.
- D Cobalt(II) chloride paper turns blue.

25 A petrol car engine takes in clean air and lets out exhaust gases.

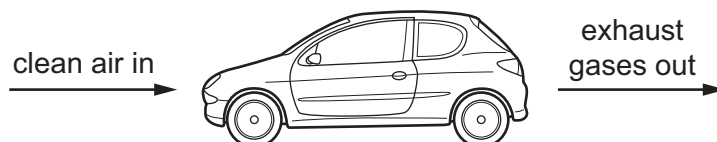

Which gas has a higher concentration in the exhaust gases than in clean air?

- A argon
  - B carbon dioxide
  - C nitrogen
  - D oxygen
- 26 Which petroleum fraction is used to make road surfaces?
- A bitumen
  - B diesel oil
  - C gasoline
  - D naphtha
- 27 Which statement about hydrocarbons is correct?
- A Alkanes are produced by cracking alkenes.
  - B Alkanes decolourise bromine water.
  - C Alkenes are saturated hydrocarbons.
  - D Alkenes contain a double bond.

28 Graph 1 is a distance–time graph. Graph 2 is a speed–time graph.

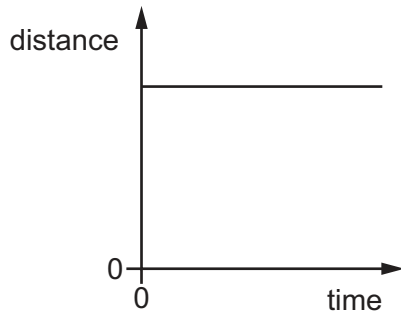

graph 1

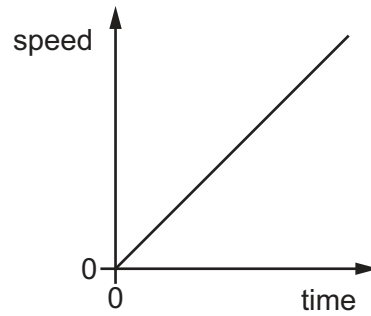

graph 2

Which of these graphs represents a car that is moving at constant speed?

- A graph 1 only
- B graph 2 only
- C both graphs
- D neither graph

29 A solid block has a mass of 1.5 kg and a volume of  $0.30 \text{ m}^3$ .

What is its density?

- A  $0.20 \text{ kg/m}^3$
- B  $0.45 \text{ kg/m}^3$
- C  $1.8 \text{ kg/m}^3$
- D  $5.0 \text{ kg/m}^3$

30 A girl holding a heavy load stands with her two feet flat on the ground.

Which change causes the pressure she exerts on the ground to increase?

- A lifting one foot off the ground
- B lying flat on the ground
- C removing the load
- D wearing skis to stand on the ground

31 Diagram 1 shows a load hanging on a spring.

Diagram 2 shows the load pulled down.

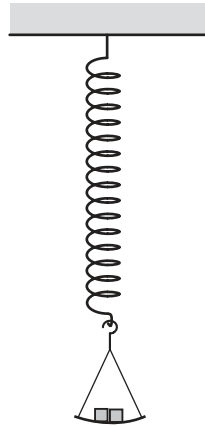

diagram 1

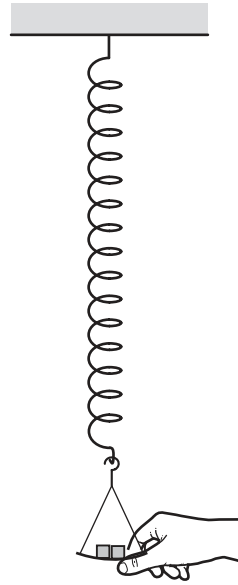

diagram 2

When the load is pulled down, what happens to the gravitational potential energy of the load and the elastic potential (strain) energy of the spring?

	gravitational potential energy of load	elastic potential energy of spring
<b>A</b>	decreases	decreases
<b>B</b>	decreases	increases
<b>C</b>	increases	decreases
<b>D</b>	increases	increases

32 In which list are all the sources of energy renewable?

- A** geothermal, hydroelectric, nuclear fission
- B** geothermal, tides, hydroelectric
- C** tides, nuclear fission, coal
- D** solar, wind, coal

33 How is thermal energy transferred from the Sun to the Earth through the vacuum of space?

- A by conduction, convection and radiation
- B by conduction only
- C by convection only
- D by radiation only

34 The diagram represents a wave that travels from P to Q.

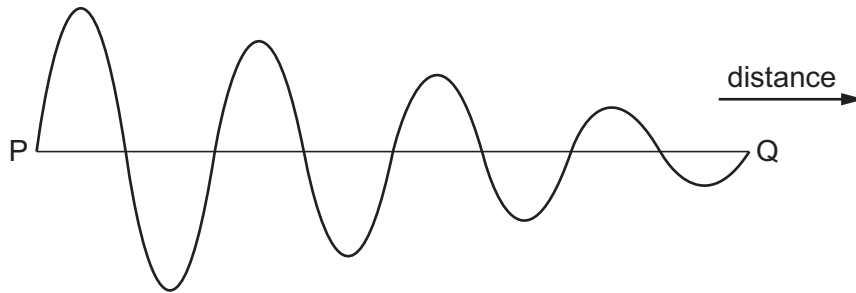

The diagram shows that one property of the wave decreases as it travels.

Which property is this?

- A amplitude
  - B frequency
  - C speed
  - D wavelength
- 35 Light in air hits a plane glass surface at an angle of incidence of  $45^\circ$ .

In which direction does the light continue?

- A along the surface of the glass
- B in the opposite direction to its original direction
- C into the glass in a new direction
- D into the glass in its original direction

- 36 What is the approximate range of frequencies of sound that can be heard by a human, and which property of a sound wave causes echoes?

	range of frequencies / Hz	property that causes echoes
<b>A</b>	2.0 to 2000	reflection
<b>B</b>	2.0 to 2000	refraction
<b>C</b>	20 to 20 000	reflection
<b>D</b>	20 to 20 000	refraction

- 37 An uncharged metal ball becomes negatively charged.

Which particles have been transferred to the ball?

- A** atoms
- B** electrons
- C** neutrons
- D** protons

- 38 A battery is connected to a resistor.

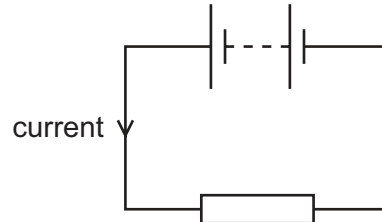

Which changes to the resistance of the resistor, and to the potential difference (p.d.) across the resistor, **must** produce a smaller current?

	resistance	p.d.
<b>A</b>	decrease	decrease
<b>B</b>	decrease	increase
<b>C</b>	increase	decrease
<b>D</b>	increase	increase

39 Which electrical component is represented by the symbol shown?

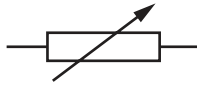

- A a fixed resistor
- B a fuse
- C a lamp
- D a variable resistor

40 The diagrams show four arrangements of resistors.

Which arrangement has the **smallest** total resistance?

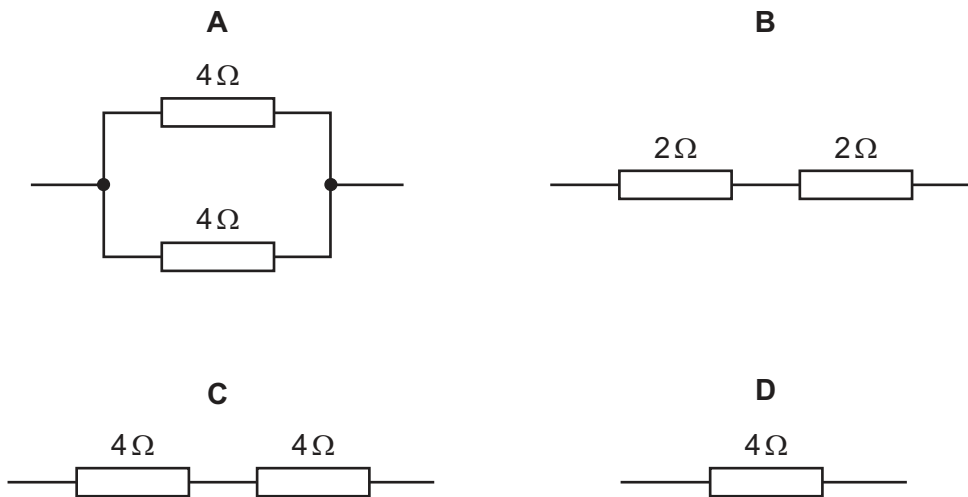

Permission to reproduce items where third-party owned material protected by copyright is included has been sought and cleared where possible. Every reasonable effort has been made by the publisher (UCLES) to trace copyright holders, but if any items requiring clearance have unwittingly been included, the publisher will be pleased to make amends at the earliest possible opportunity.

To avoid the issue of disclosure of answer-related information to candidates, all copyright acknowledgements are reproduced online in the Cambridge Assessment International Education Copyright Acknowledgements Booklet. This is produced for each series of examinations and is freely available to download at [www.cambridgeinternational.org](http://www.cambridgeinternational.org) after the live examination series.

Cambridge Assessment International Education is part of the Cambridge Assessment Group. Cambridge Assessment is the brand name of the University of Cambridge Local Examinations Syndicate (UCLES), which itself is a department of the University of Cambridge.

The Periodic Table of Elements

		Group															
I	II	III	IV	V	VI	VII	VIII										
3 <b>Li</b> lithium 7	4 <b>Be</b> beryllium 9	<div style="border: 1px solid black; padding: 5px; text-align: center;"> <b>Key</b>                      atomic number                      atomic symbol                      name                      relative atomic mass                 </div>										1 <b>H</b> hydrogen 1					
11 <b>Na</b> sodium 23	12 <b>Mg</b> magnesium 24											5 <b>B</b> boron 11	6 <b>C</b> carbon 12	7 <b>N</b> nitrogen 14	8 <b>O</b> oxygen 16	9 <b>F</b> fluorine 19	10 <b>Ne</b> neon 20
19 <b>K</b> potassium 39	20 <b>Ca</b> calcium 40	21 <b>Sc</b> scandium 45	22 <b>Ti</b> titanium 48	23 <b>V</b> vanadium 51	24 <b>Cr</b> chromium 52	25 <b>Mn</b> manganese 55	26 <b>Fe</b> iron 56	27 <b>Co</b> cobalt 59	28 <b>Ni</b> nickel 59	29 <b>Cu</b> copper 64	30 <b>Zn</b> zinc 65	31 <b>Ga</b> gallium 70	32 <b>Ge</b> germanium 73	33 <b>As</b> arsenic 75	34 <b>Se</b> selenium 79	35 <b>Br</b> bromine 80	36 <b>Kr</b> krypton 84
37 <b>Rb</b> rubidium 85	38 <b>Sr</b> strontium 88	39 <b>Y</b> yttrium 89	40 <b>Zr</b> zirconium 91	41 <b>Nb</b> niobium 93	42 <b>Mo</b> molybdenum 96	43 <b>Tc</b> technetium —	44 <b>Ru</b> ruthenium 101	45 <b>Rh</b> rhodium 103	46 <b>Pd</b> palladium 106	47 <b>Ag</b> silver 108	48 <b>Cd</b> cadmium 112	49 <b>In</b> indium 115	50 <b>Sn</b> tin 119	51 <b>Sb</b> antimony 122	52 <b>Te</b> tellurium 128	53 <b>I</b> iodine 127	54 <b>Xe</b> xenon 131
55 <b>Cs</b> caesium 133	56 <b>Ba</b> barium 137	57–71 lanthanoids	72 <b>Hf</b> hafnium 178	73 <b>Ta</b> tantalum 181	74 <b>W</b> tungsten 184	75 <b>Re</b> rhenium 186	76 <b>Os</b> osmium 190	77 <b>Ir</b> iridium 192	78 <b>Pt</b> platinum 195	79 <b>Au</b> gold 197	80 <b>Hg</b> mercury 201	81 <b>Tl</b> thallium 204	82 <b>Pb</b> lead 207	83 <b>Bi</b> bismuth 209	84 <b>Po</b> polonium —	85 <b>At</b> astatine —	86 <b>Rn</b> radon —
87 <b>Fr</b> francium —	88 <b>Ra</b> radium —	89–103 actinoids	104 <b>Rf</b> rutherfordium —	105 <b>Db</b> dubnium —	106 <b>Sg</b> seaborgium —	107 <b>Bh</b> bohrium —	108 <b>Hs</b> hassium —	109 <b>Mt</b> meitnerium —	110 <b>Ds</b> darmstadtium —	111 <b>Rg</b> roentgenium —	112 <b>Cn</b> copernicium —	114 <b>Fl</b> flerovium —	116 <b>Lv</b> livermorium —	—	—	—	—

lanthanoids	57 <b>La</b> lanthanum 139	58 <b>Ce</b> cerium 140	59 <b>Pr</b> praseodymium 141	60 <b>Nd</b> neodymium 144	61 <b>Pm</b> promethium —	62 <b>Sm</b> samarium 150	63 <b>Eu</b> europium 152	64 <b>Gd</b> gadolinium 157	65 <b>Tb</b> terbium 159	66 <b>Dy</b> dysprosium 163	67 <b>Ho</b> holmium 165	68 <b>Er</b> erbium 167	69 <b>Tm</b> thulium 169	70 <b>Yb</b> ytterbium 173	71 <b>Lu</b> lutetium 175
actinoids	89 <b>Ac</b> actinium —	90 <b>Th</b> thorium 232	91 <b>Pa</b> protactinium 231	92 <b>U</b> uranium 238	93 <b>Np</b> neptunium —	94 <b>Pu</b> plutonium —	95 <b>Am</b> americium —	96 <b>Cm</b> curium —	97 <b>Bk</b> berkelium —	98 <b>Cf</b> californium —	99 <b>Es</b> einsteinium —	100 <b>Fm</b> fermium —	101 <b>Md</b> mendelevium —	102 <b>No</b> nobelium —	103 <b>Lr</b> lawrencium —

The volume of one mole of any gas is 24 dm<sup>3</sup> at room temperature and pressure (r.t.p.).